

Description

DL3321D3LC a 3.3V bi-directional TVS diode, utilizing leading monolithic silicon technology to provide fast response time and low ESD clamping voltage, making his device an ideal solution for protecting voltage sensitive high-speed data lines. The DL3321D3LC has a low capacitance with a typi-cal value at 0.6 pF, and complies with the IEC61000-4-2 (ESD) standard with $\pm 30\text{kV}$ air and $\pm 30\text{kV}$ contact discharge. It is assembled into a lead-free SOD-323 package. The small size, low capaci-tance and high ESD surge protection make DL3321D3LC an idea choice to protect cell phone, wireless systems, and communication equipment.

Features

- ◆ 350W peak pulse power (8/20 μs)
- ◆ Ultra low capacitance : 0.6pF typical
- ◆ Ultra low leakage: nA level
- ◆ Low Operating: 3.3V
- ◆ Low clamping voltage
- ◆ Protects one power line or data line
- ◆ Complies with following standards:
 - IEC 61000-4-2 (ESD) immunity test Air discharge: $\pm 30\text{kV}$
Contact discharge: $\pm 30\text{kV}$
 - IEC61000-4-5 (Lightning) 20A (8/20 μs)
- ◆ RoHS Compliant

Mechanical Characteristics

- ◆ Package: SOD-323
- ◆ Lead Finish: Matte Tin
- ◆ Case Material: “Green” Molding Compound.
- ◆ Moisture Sensitivity: Level 3 per J-STD-020
- ◆ Terminal Connections: See Diagram Below
- ◆ Marking Information: See Below

Applications

- ◆ USB Ports
- ◆ Smart Phones
- ◆ Wireless Systems
- ◆ Ethernet 10/100/1000 Base T

Dimensions and Pin Configuration

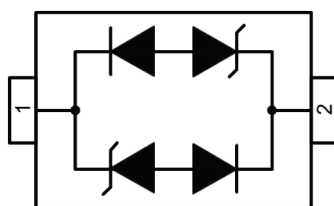

Circuit and Pin Schematic

Marking Information



CC : Device Marking Code

Ordering Information

Part Number	Marking	Packaging	Reel Size
DL3321D3LC	CC	3000/Tape & Reel	7 inch

Absolute Maximum Ratings ($T_A=25^{\circ}\text{C}$ unless otherwise specified)

Parameter	Symbol	Value	Unit
Peak Pulse Power (8/20 μs)	Ppk	350	W
Peak Pulse Current (8/20 μs)	I _{PP}	20	A
ESD per IEC 61000-4-2 (Air) ESD per IEC 61000-4-2 (Contact)	V _{ESD}	± 30 ± 30	kV
Operating Temperature Range	T _J	-55 to +125	$^{\circ}\text{C}$
Storage Temperature Range	T _{stg}	-55 to +150	$^{\circ}\text{C}$

Electrical Characteristics ($T_A=25^{\circ}\text{C}$ unless otherwise specified)

Parameter	Symbol	Min	Typ	Max	Unit	Test Condition
Reverse Working Voltage	V _{RWM}			3.3	V	
Pouch-Through Voltage	V _{PT}	3.5			V	I _T = 2 μA
Breakdown Voltage	V _{BR}	4	5.2	6	V	I _T = 1mA
Snap-Back Voltage	V _{BR}	2.8			V	I _T = 50mA
Reverse Leakage Current	I _R		1	500	nA	V _{RWM} = 3.3V
Clamping Voltage	V _C			6.5	V	I _{PP} = 1A (8 x 20 μs pulse)
Clamping Voltage	V _C			16	V	I _{PP} = 20A (8 x 20 μs pulse)
Junction Capacitance	C _J		0.6		pF	V _R = 0V, f = 1MHz

Typical Performance Characteristics (TA=25°C unless otherwise Specified)

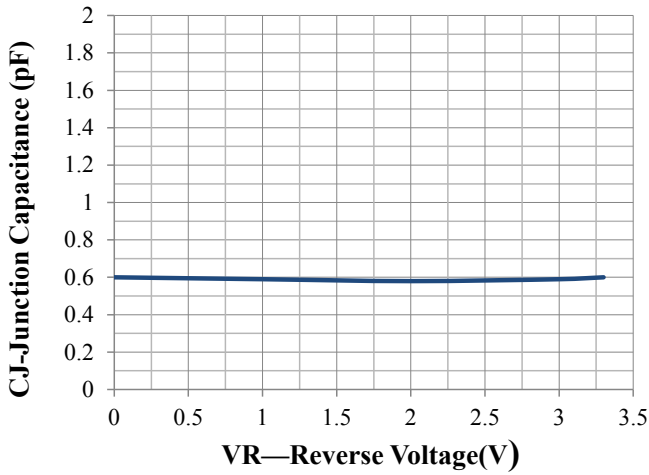

Junction Capacitance vs. Reverse Voltage

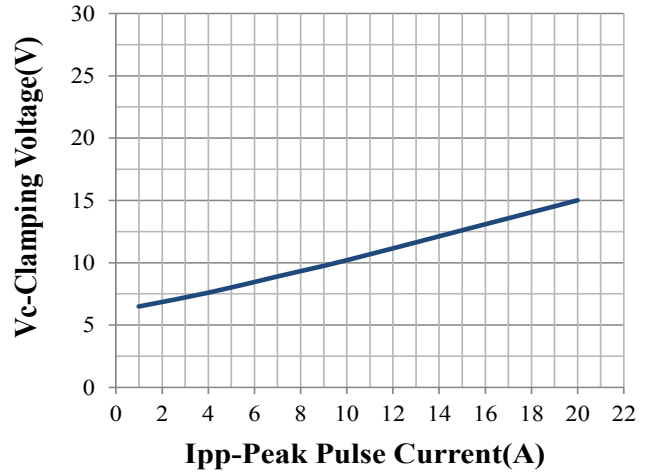

Clamping Voltage vs. Peak Pulse Current

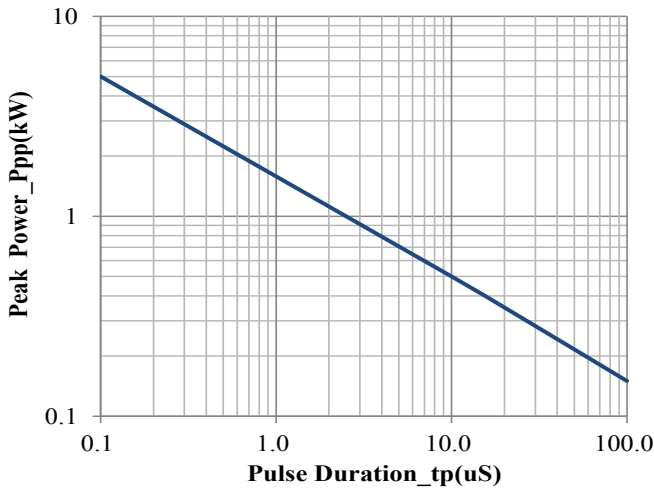

Peak Pulse Power vs. Pulse Time

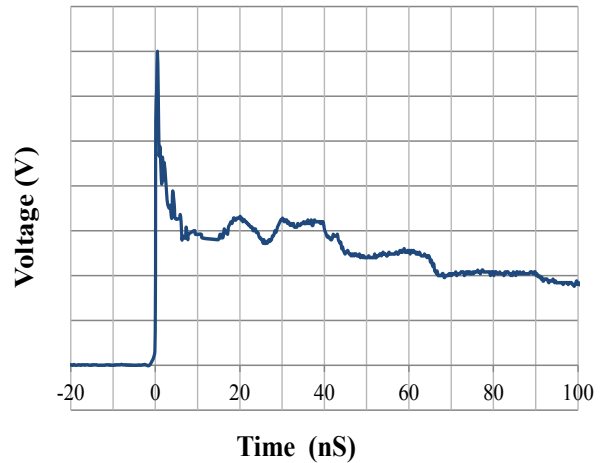

IEC61000-4-2 Pulse Waveform

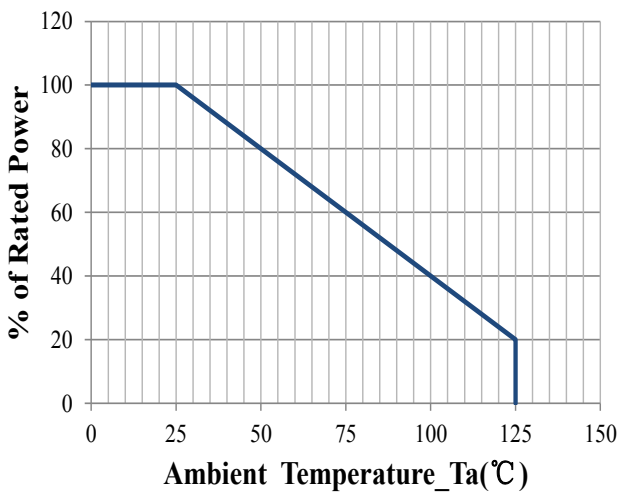

Power Derating Curve

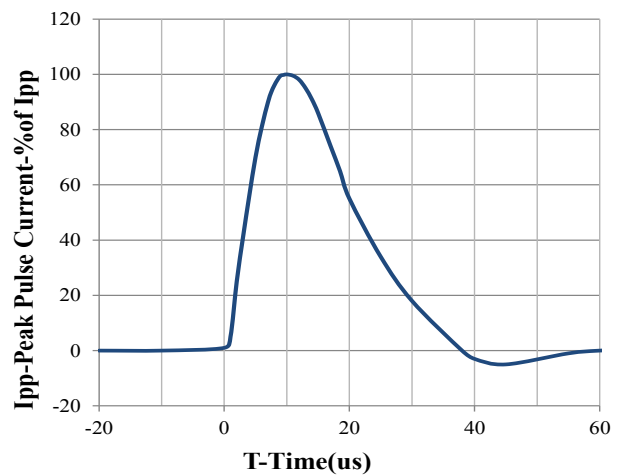

8 X 20us Pulse Waveform

SOD-323 Package Outline Drawing

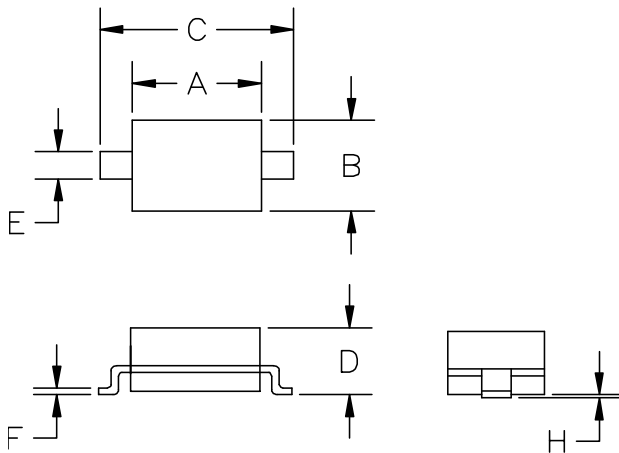

SYM	DIMENSIONS			
	MILLIMETERS		INCHES	
	MIN	MAX	MIN	MAX
A	1.50	1.80	0.060	0.071
B	1.20	1.40	0.045	0.054
C	2.30	2.70	0.090	0.107
D	-	1.10	-	0.043
E	0.30	0.40	0.012	0.016
F	0.10	0.25	0.004	0.010
H	-	0.10	-	0.004

Suggested Land Pattern



SYM	DIMENSIONS	
	MILLIMETERS	INCHES
A	3.15	0.120
B	0.80	0.031
C	0.80	0.031

Contact Information

Changzhou D-first Electronics CO.,Ltd.

www.first-electronic.com

Email: xhf@first-electronic.cn

Phone: +86 (0519) 88171671